

Lowprofile lightbars VxL

Configuration system

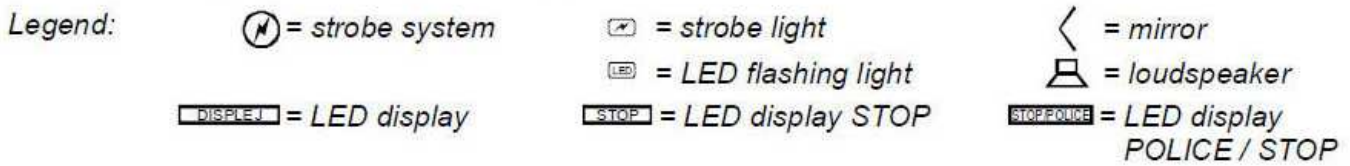
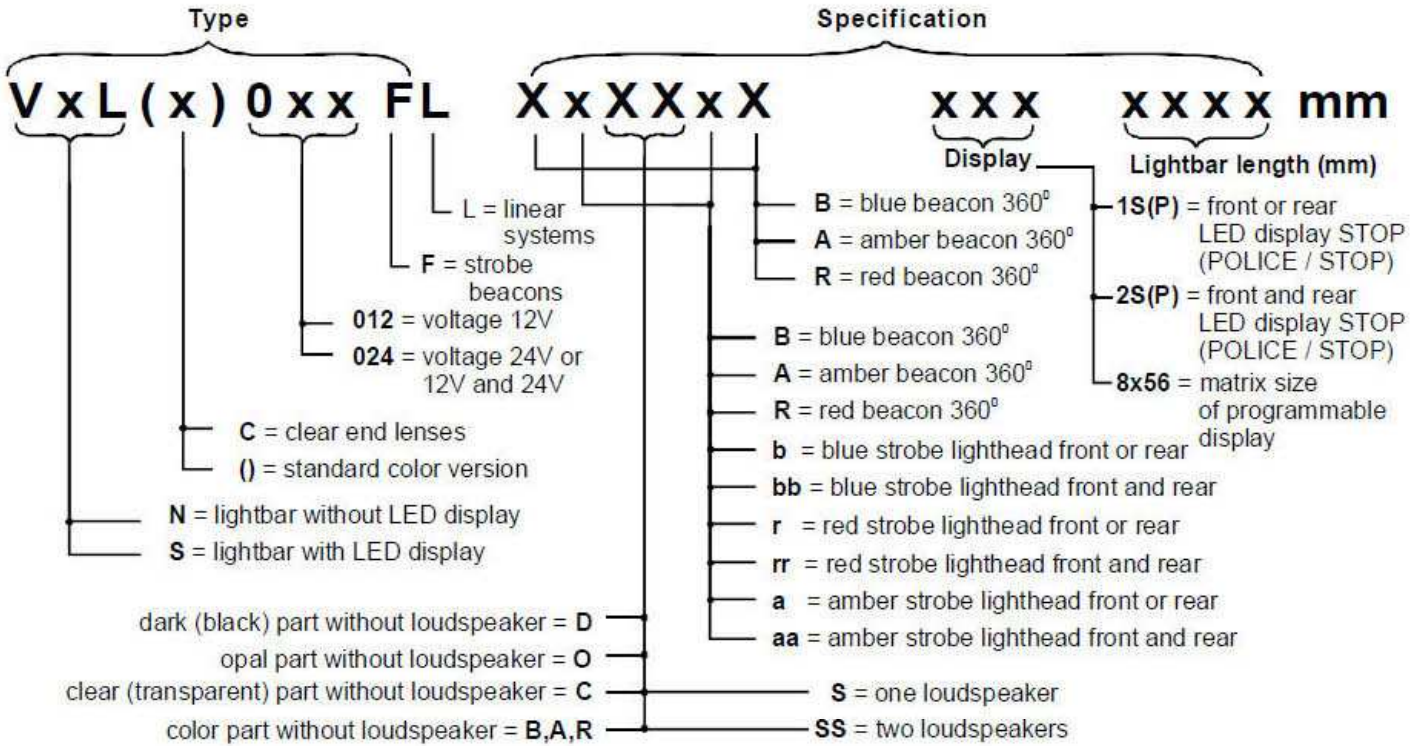

STROBE LIGHTBARS WITH LED DISPLAY

			DISPLAY	LENGTH
	VSL 012F	BSB		972 mm
	VSL 024F	RSB RSR	1S 2S	
	VSL 012F	BSB		1092 mm 1192 mm
	VSL 024F	RSB RSR	1SP 2SP	
	VSL 012F	BSB		1092 mm 1192 mm
	VSL 024F	RSB RSR	1S 2S	
	VSL 012F	BbSbB		1192 mm
	VSL 024F	RrSrB RrSrR	1SP 2SP	

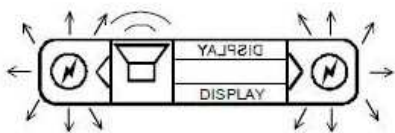

VSL 012F	BSB	PROGRAMMABLE DISPLAY	
VSL 024F	RSB	8x56	
	RSR	(optionally both front and rear display)	1192 mm

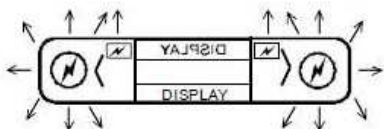

VSL 012F	BbCbB	PROGRAMMABLE DISPLAY	
VSL 024F	RrCbB	8x56	
	RrCrR	(optionally both front and rear display)	1092 mm
			1192 mm

STROBE LIGHTBARS WITHOUT LED DISPLAY

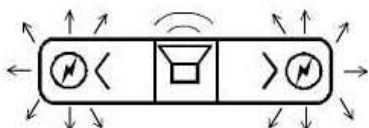

VNL 012F	BSB		972 mm
VNL 024F	RSB		1092 mm 1362 mm
	RSR		1192 mm 1492 mm

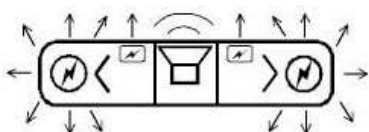

VNL 024F	BbSbB		972 mm
	RrSbB		1092 mm 1362 mm
	RrSrR		1192 mm 1492 mm

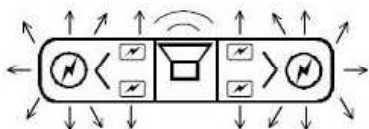

VNL 024F	BbbSbbB		
	RrrSbbB		1092 mm 1362 mm
	RrrSrrR		1192 mm 1492 mm

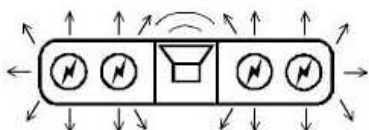

VNL 024F	BBSBB		
	RRSBB		1362 mm
	RRSRR		1192 mm 1492 mm

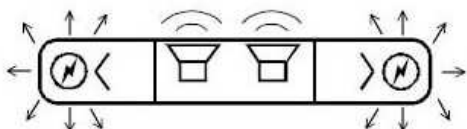

VNL 012F	BSSB		
VNL 024F	RSSB		1362 mm
	RSSR		1492 mm

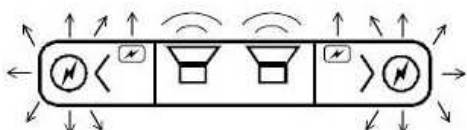

VNL 024F	BbSSbB		
	RrSSbB		1362 mm
	RrSSrR		1492 mm

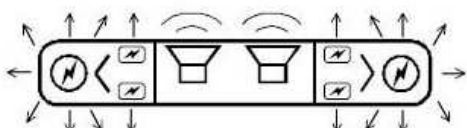

VNL 024F	BbbSSbbB		
	RrrSSbbB		1362 mm
	RrrSSrrR		1492 mm

Lightbars VNL 024F configured with strobe lights only are designed for both supply voltage 12V and 24V. Directive is indication at type label. Strobe lights might be replaced by LED lights.